

Freestanding iPad Stand

Black: PAD12-02A-BLACK

White: PAD12-02A-WHITE

Silver: PAD12-02A-SILVER

The Freestanding iPad Stand is a smart, lightweight and portable holder used to display the iPad 2nd, 3rd or 4th generations. It can be positioned in either portrait or landscape configurations. Security screws, allen key and bolts make the unit both durable and theft resistant. For extra security, the base can also be bolted to the floor.



Portrait view



Landscape view



Back

We are continually improving and modifying our product range and reserve the right to vary the specifications without prior notice. All dimensions and weights quoted are approximate and we accept no responsibility for variance. E&OE. See Graphic Templates for graphic bleed specifications.

features and benefits:

- Available in black, white or silver finish
- Holder compatible with 2nd, 3rd or 4th iPad generations
- Can be positioned in either portrait or landscape view
- Made from steel
- Quick to set up
- Security screws/Allen key and bolts make unit both durable and theft resistant
- Unit can be bolted to floor
- One year hardware warranty against manufacturer defects











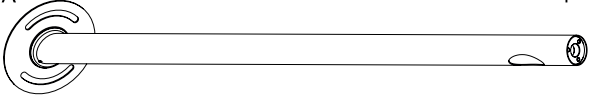

dimensions:

Hardware	Shipping
<p>Assembled unit:</p> <p>Landscape view: 14.17" w x 41.14" h 360mm(w) x 1045mm(h)</p> <p>Portrait view: 14.17" w x 41.73" h 360mm(w) x 1060mm(h)</p> <p>Weight: 9.25 lbs / 4.2 kg</p>	<p>Shipping dimensions - unit ships in 1 box: 40.5" l x 15" w x 6" h 1029mm(l) x 381mm(w) x 152mm(h)</p> <p>Shipping weight: 15 lbs / 6.8 kg</p>

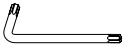
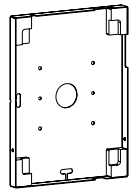
additional information:

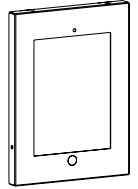
- *iPad not included
- *Power cord not included
- iPad must be removed from face plate after use; storing iPad in the unit during transit is not recommended
- Includes rubberized push button or black button cover for iPad home button
- Packaged well in foam protective covering
- Unit cannot be shipped in molded case due to parts possibly getting scratched

Parts Included:

Part No. / Description	Qty	Part No. / Description	Qty
A  tube	1	G  M5x8(tamper-proof screw)	4
B  plastic cover	1	H  M5x20	3
C  washer	1	I  $\Phi 13.5 \times \Phi 5.5 \times 3.2$	2
D  base	1	J  TORX tool	1
E  rear cover	1	K  ST6.3x55	3
F  front cover	1	L  Concrete anchor	3
		M  Turn-knob	1
		N  D5 washer	2

*Parts B, C, G-N are packaged together in 1 bag

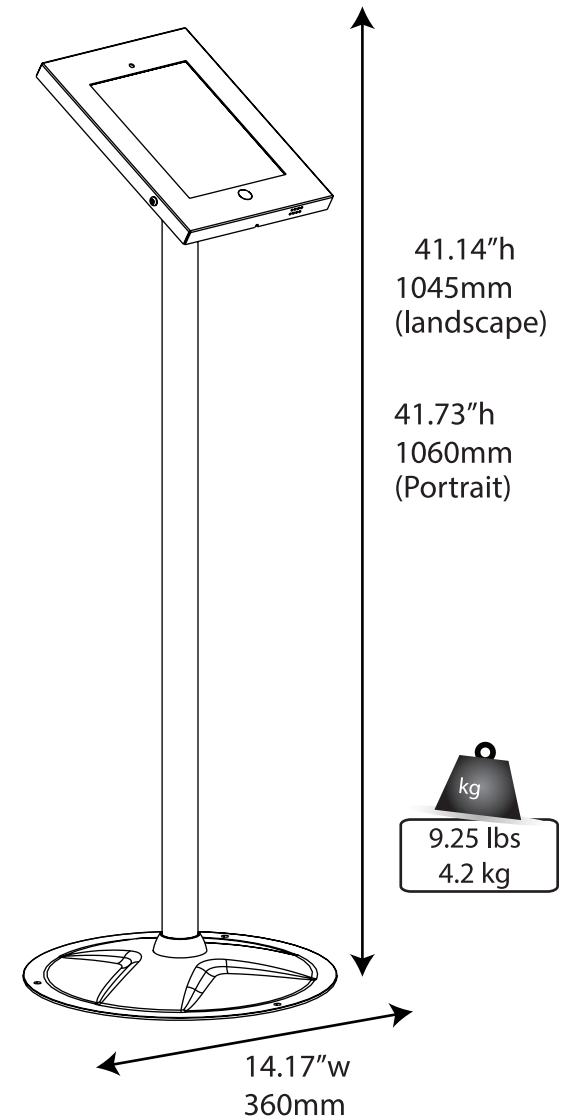

Set-up:

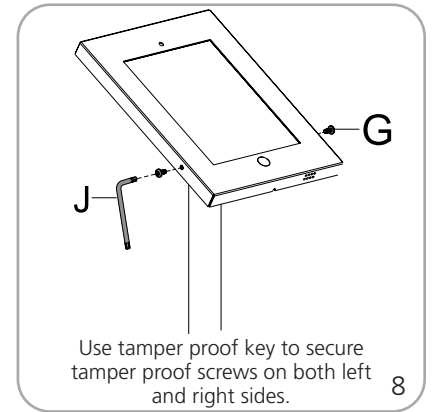
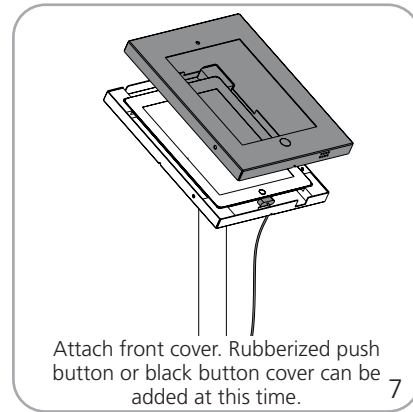
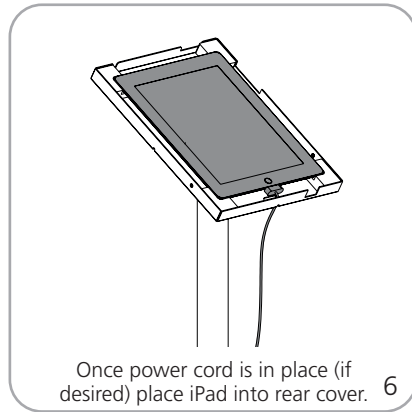
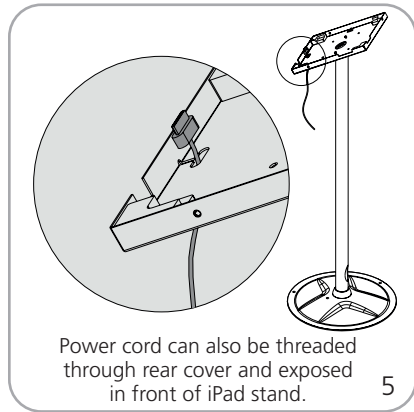
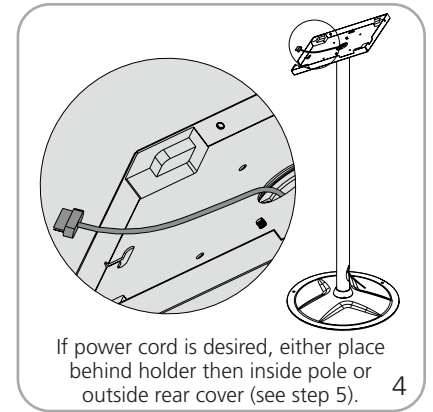
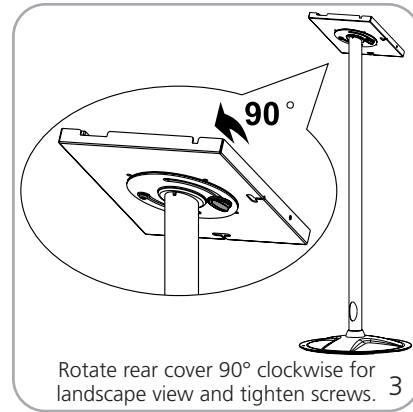
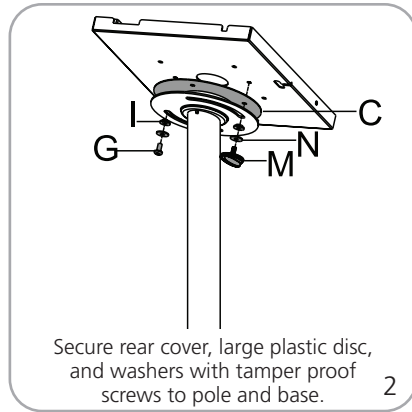
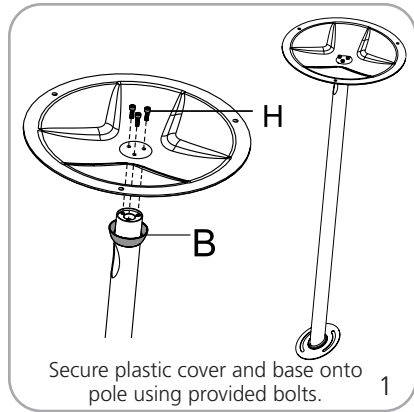

Optional Base Attachment:

