

Formulate Designer Series 20' Backwall - Kit 07

FMLT-DS-20-07

Formulate™ Designer Series 20ft displays have unique stylistic features and shapes, are portable and easy to assemble. The aluminum tube frame features snap-buttons and zipper pillowcase fabric graphics. All displays come in portable, wheeled transit cases. Simply pull the pillowcase fabric graphic over the frame and zip.



features and benefits:

- Premium aluminum tube frames with spigot and snap button assembly
- Easy to store and ship
- Quick to set up
- Weighted feet for added stability
- Zipper pillowcase fabric graphic
- Kit includes: monitor kiosk featuring a medium monitor mount, can hold 32-55" monitor / max weight 40lbs
- Lifetime limited hardware warranty against manufacturer defects

dimensions:

Hardware

Assembled unit:
228" w x 98" h x 20" d
5791.2mm(w) x 2489.2mm(h) x 508mm(d)

Approximate weight with cases:
368 lbs / 166.9 kgs

Shipping

Packing case(s):
5 OCE Cases

Shipping dimensions:
OCE: Expandable case length (l) may vary
40" - 66" l x 18" w x 18" h
1016mm-1677mm(l) x 458mm(w) x 458mm(h)

Approximate total shipping weight
(includes cases & graphics):
399 lbs / 180.9 kgs

Graphic

Refer to related graphic template for more information.

Visit:
www.exhibitors-handbook.com/graphic-templates

additional information:

Graphic material:
dye-sublimation zipper pillowcase fabric

We are continually improving and modifying our product range and reserve the right to vary the specifications without prior notice. All dimensions and weights quoted are approximate and we accept no responsibility for variance. E&OE. See Graphic Templates for graphic bleed specifications.

Included In Your Kit

Tools, Components, & Connectors



ALLEN KEY SET x1



ES30 x11



ES50 x8



LN114-S2-650 x2



SG-50-2W x2



TC-30-A-90° x4



TC-50-90T x8



LN114-SCRW x2



PM4S3-MK-M x2

Graphics

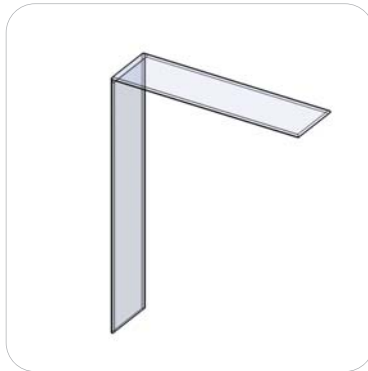

FMLT-DS-20-07-A-G

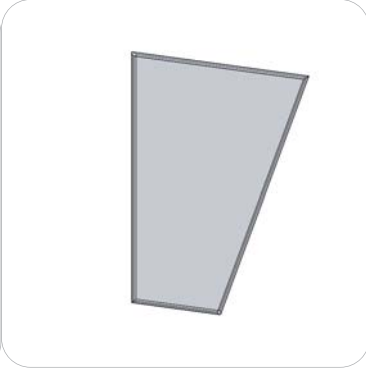

FMLT-DS-20-07-B-G

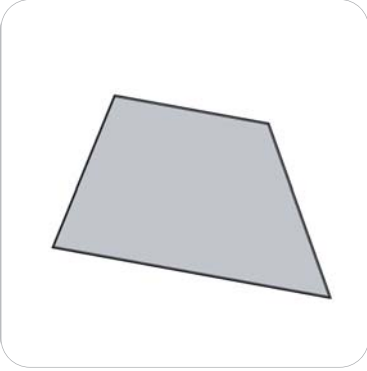

FMLT-DS-20-07-C-G

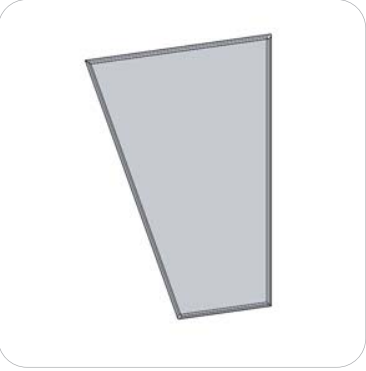

FMLT-DS-20-07-D-G



FMLT-DS-20-07-E-G

Included In Your Kit

Tubes



DS-20-07-A-T1 x8



DS-20-07-A-T2 x4



DS-20-07-A-T3 x4



DS-20-07-A-T4 x8



DS-20-07-A-T5 x4



DS-20-07-A-T6 x4

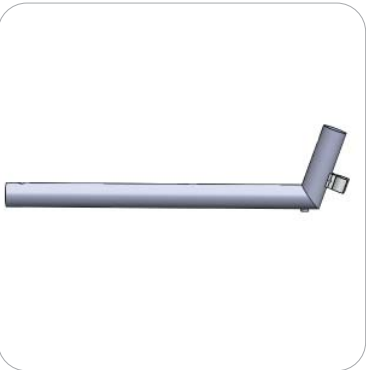

DS-20-07-B-T1 x2



DS-20-07-B-T2 x6



DS-20-07-B-T3 x2



DS-20-07-B-T4 x2



DS-20-07-C-T1 x2



DS-20-07-C-T2 x2



DS-20-07-C-T3 x2



DS-20-07-C-T4 x4



DS-20-07-C-T5 x2

Exploded View

FMLT-DS-20-07

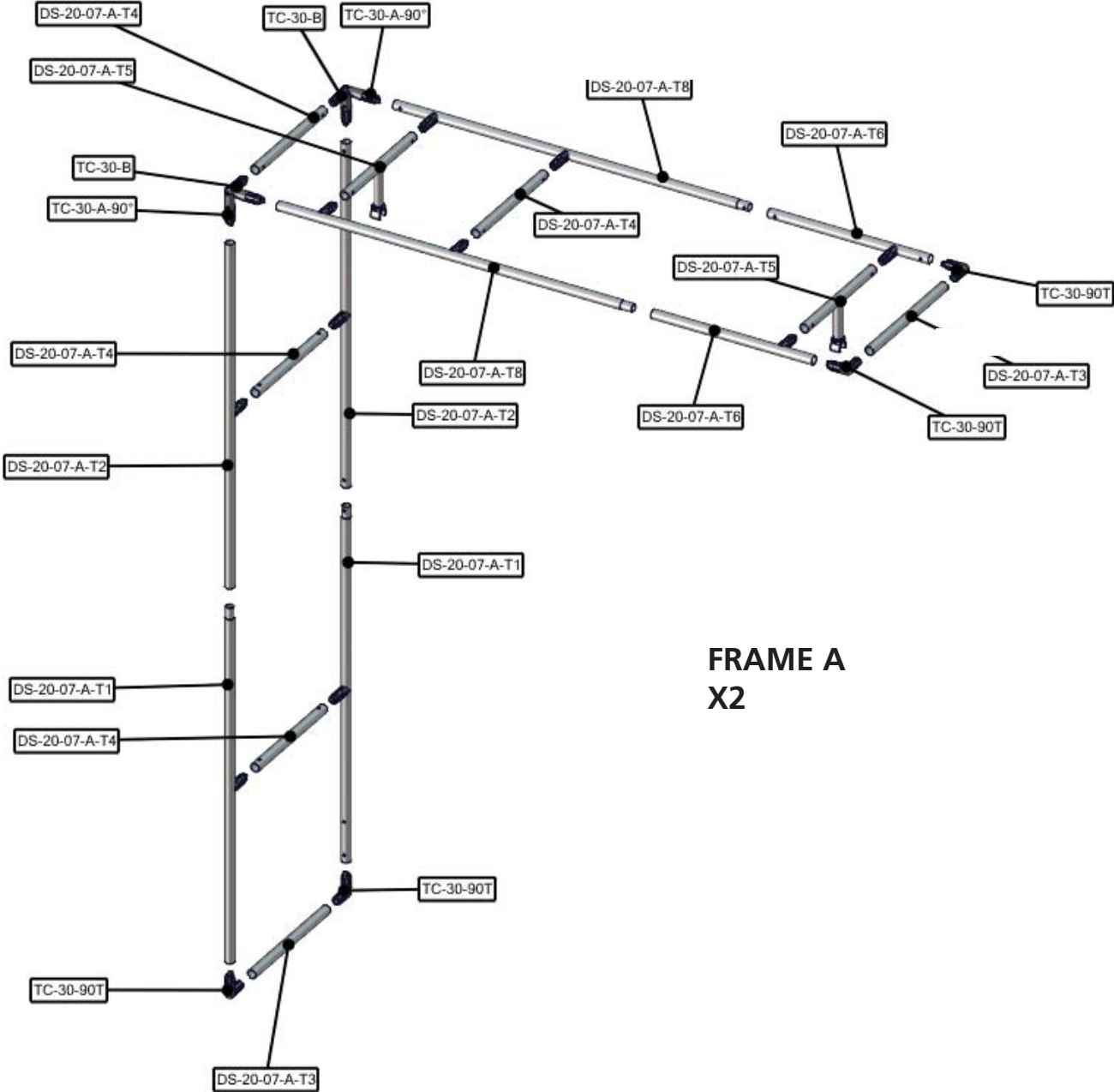

FRAME A
X2

Exploded View

FMLT-DS-20-07

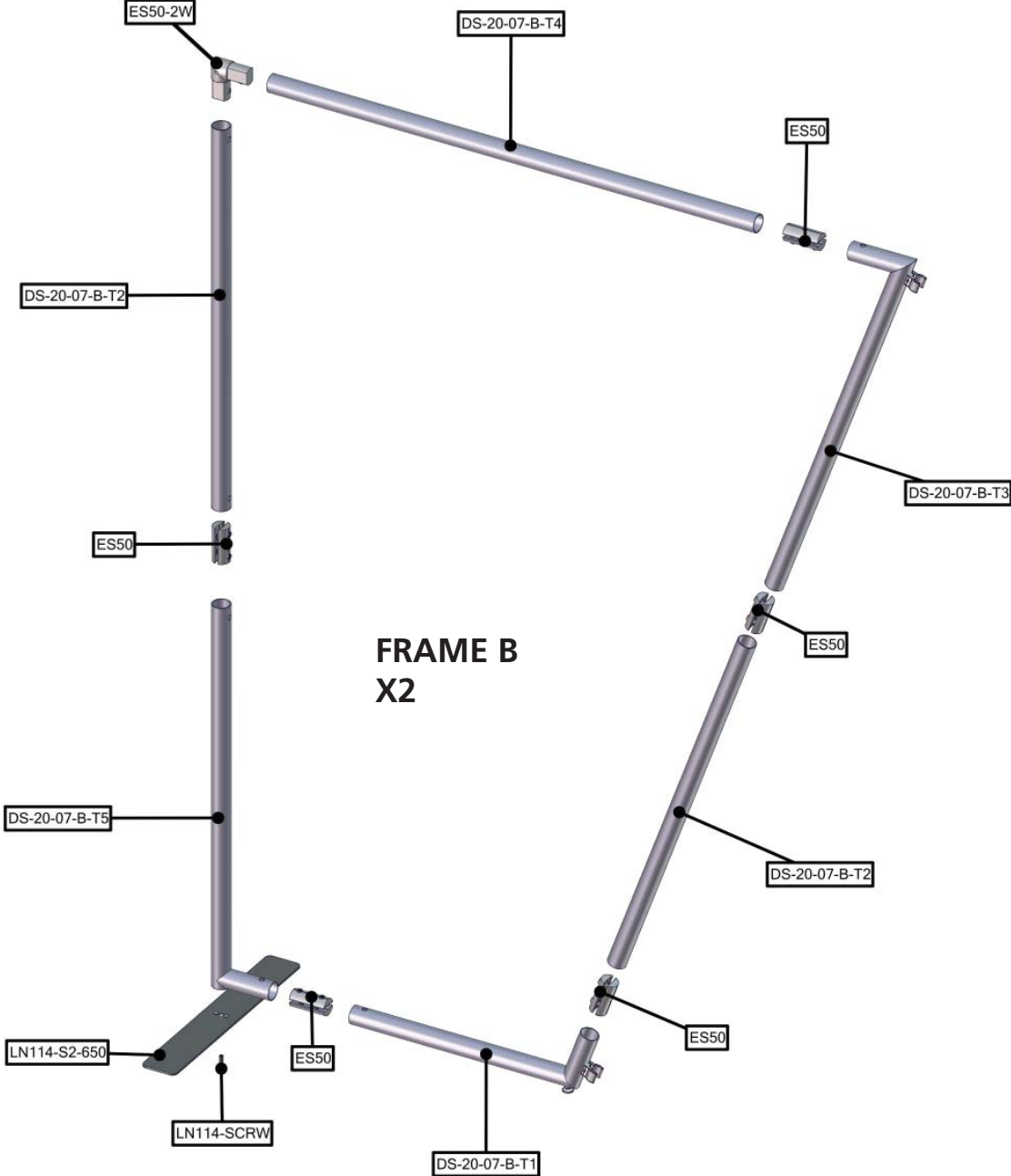

Exploded View

FMLT-DS-20-07

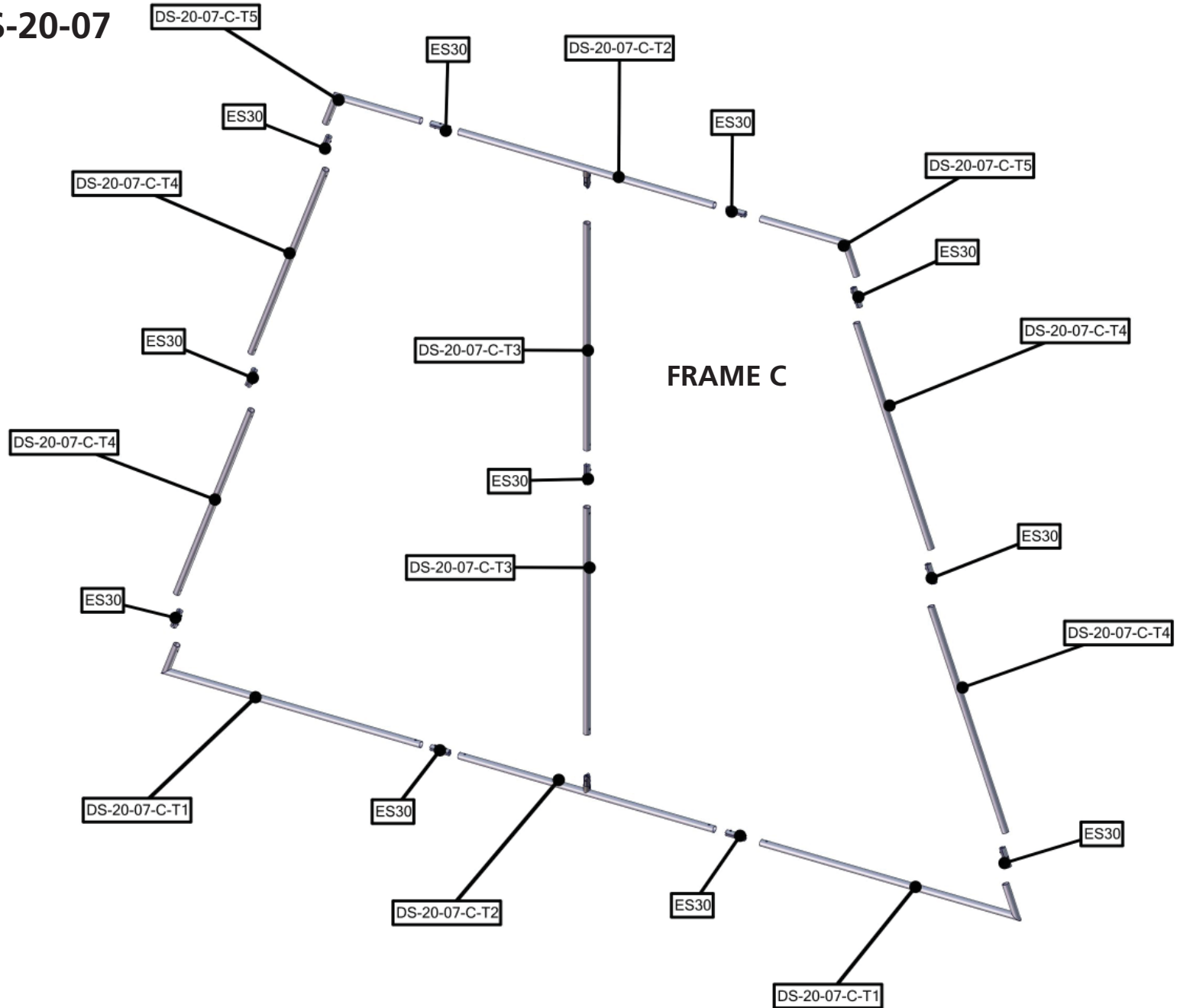

Labeling Diagram

FMLT-DS-20-07

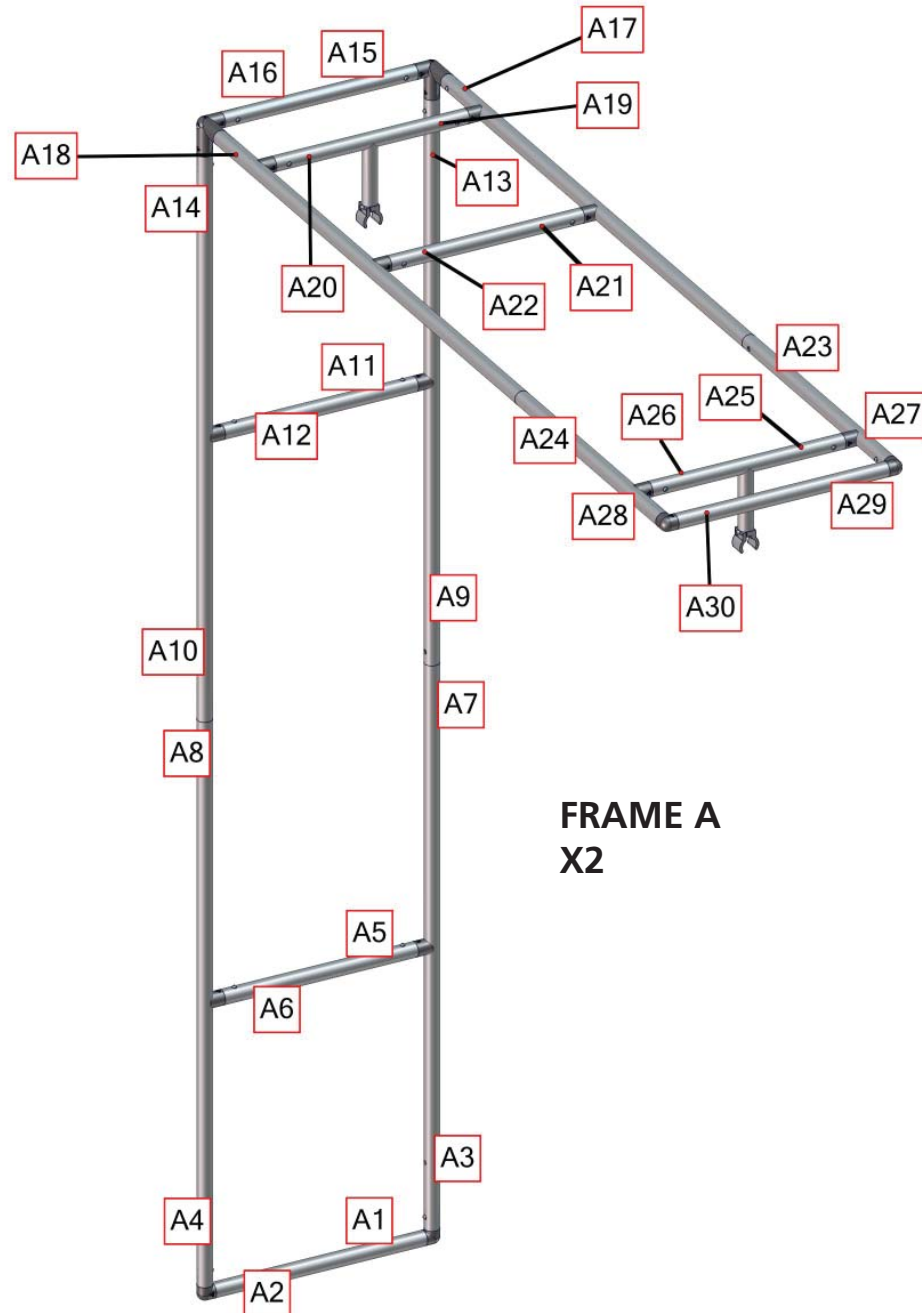

Labeling Diagram

FMLT-DS-20-07

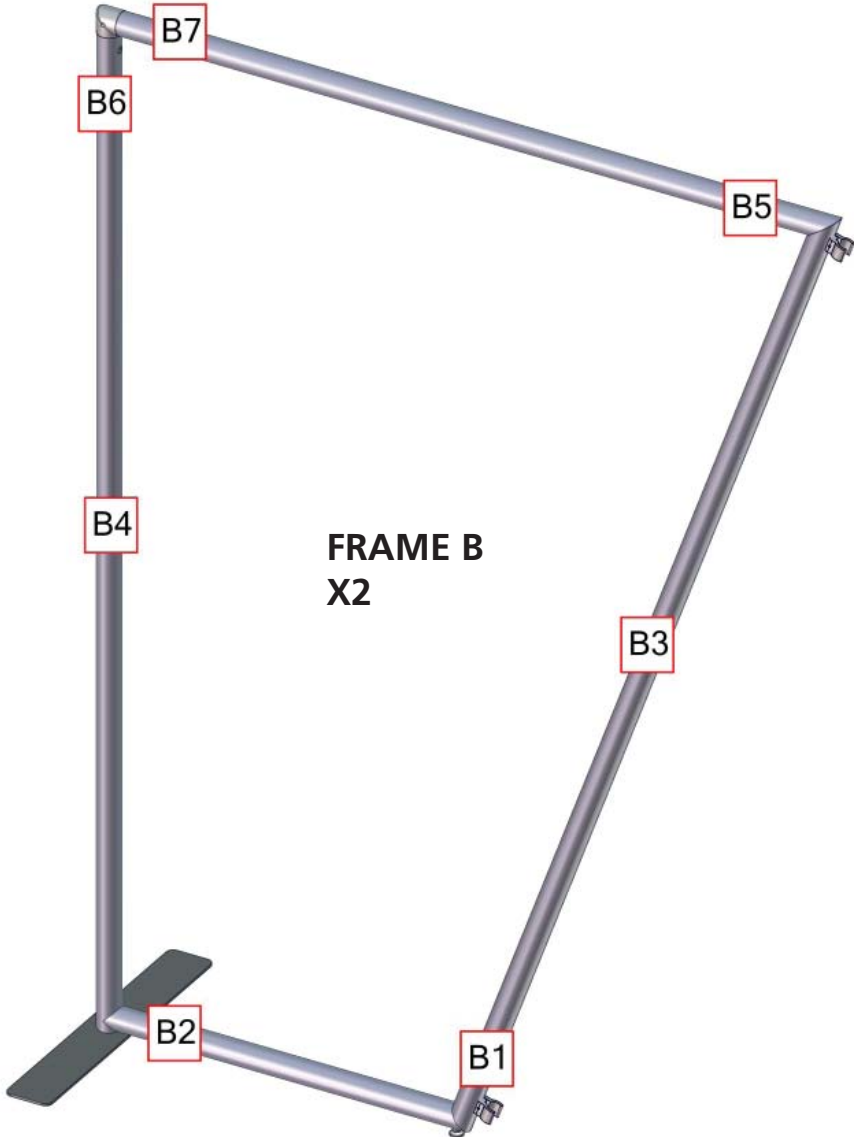

Labeling Diagram

FMLT-DS-20-07

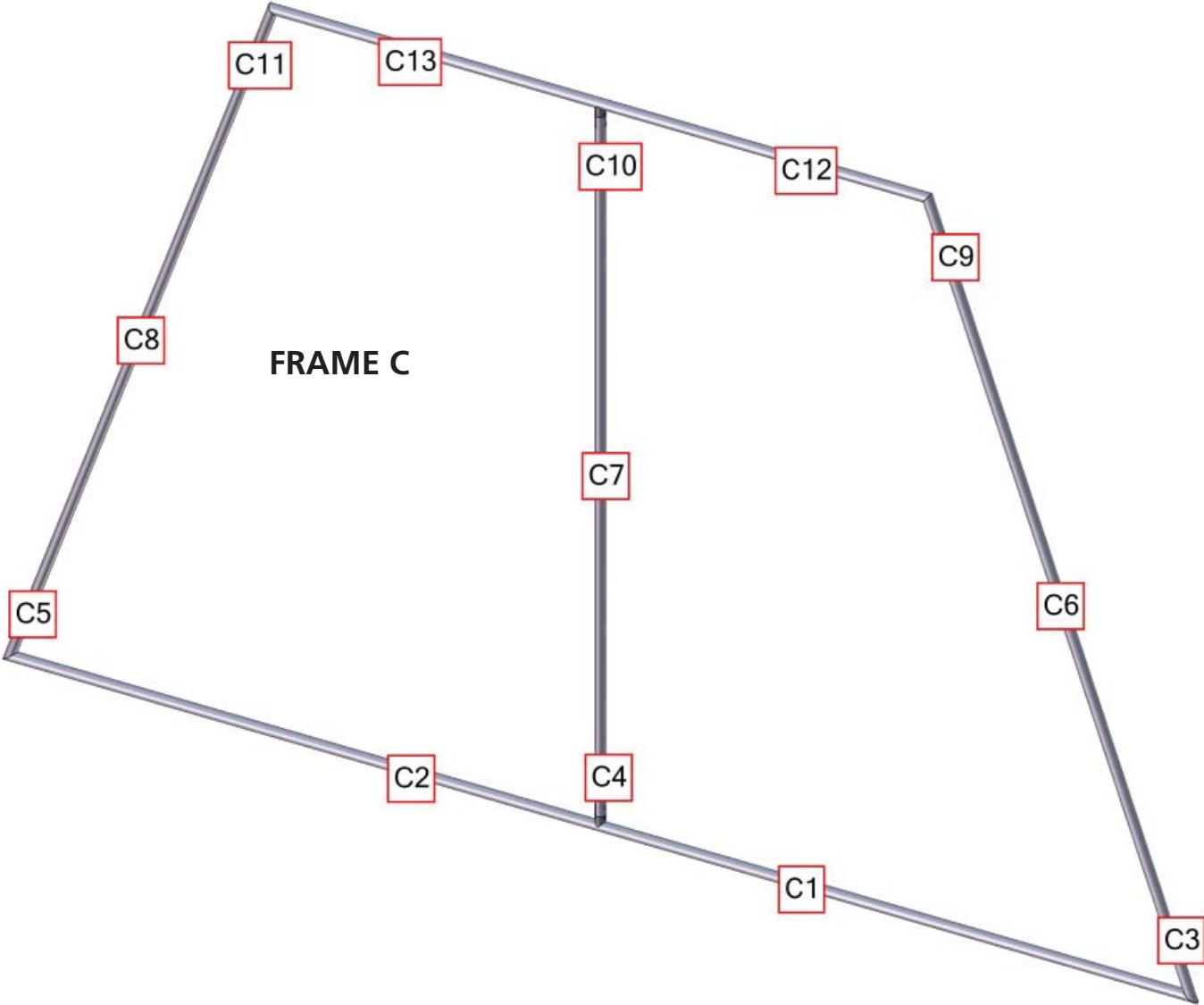

Connection Methods

Connection Method 1: ES30 / ES50 / ES75

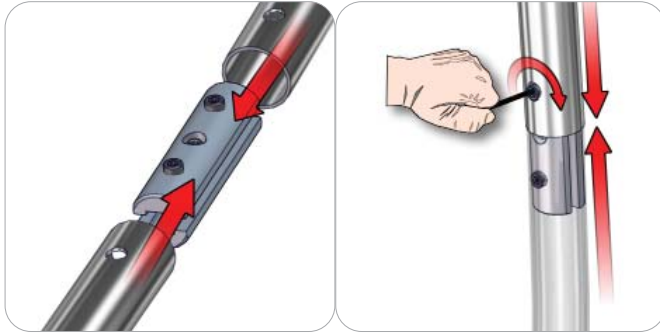

Compress the unlocked connector and slide one tube onto each end. Lock both screws carefully using your allen key tool. Be sure to lock securely, but do not overtighten.

Connection Method 2: Snap Buttons & Swage

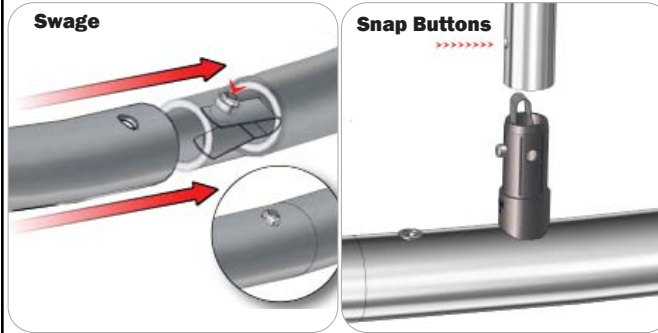

Locate the snap button on the connector or swage tube. Locate the hole on the corresponding tube. Press the snap button with your thumb and slide the tube and connector together so that the snap button snaps fully into the lock hole. To disassemble, press the snap button and pull apart.

Connection Method 3: ES30-90B / ES30-I / ES30-C

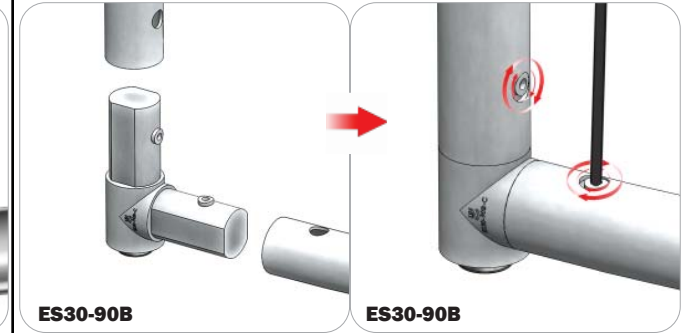

Compress one unlocked end of the connector and slide it through one tube end. Compress the other end of the connector and slide the second tube on. Lock both screws carefully using your allen key tool. Be sure to lock securely, but do not overtighten.

Connection Method 4: Tube Clamps

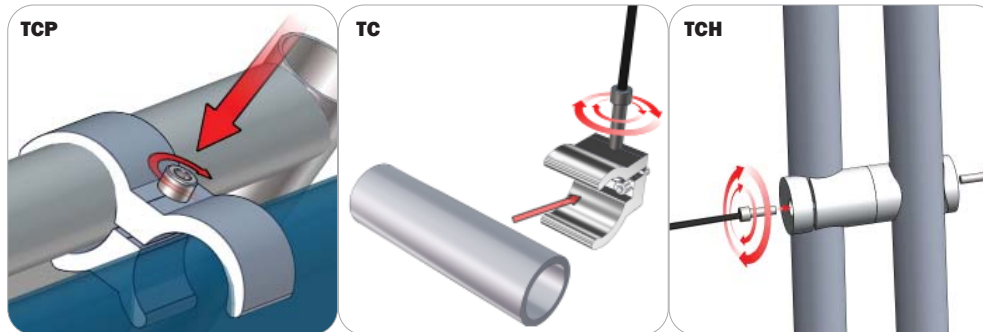

Be sure to fully assemble all frames before using clamps. With the clamp unlocked, place one tube of the first frame into the mouth of the clamp. Place the second tube (if applicable) into the second mouth of the clamp. With both frame's tubes in the clamp, be sure to lock securely, but do not overtighten.

Kit Assembly

Step by Step

Step 1.

Gather the components necessary for assembling both Frame A frames and lay them flat on the floor. Assemble in the order the Labeling Diagram instructs.

Please reference Connection Method 2 for more details



Step 2.

With Frame A laying flat on the floor, locate your pillowcase A graphic. With the pillowcase unzipped, encase Frame A by covering the frame from Bottom to Top. Repeat this step with graphic E onto your second Frame A.

Zipper located to the top of Graphic A & E



Step 3.

Gather the components necessary for assembling both Frame B and lay them flat on the floor. Assemble in the order the Labeling Diagram instructs.

Please reference Connection Method 1 and 3 more details

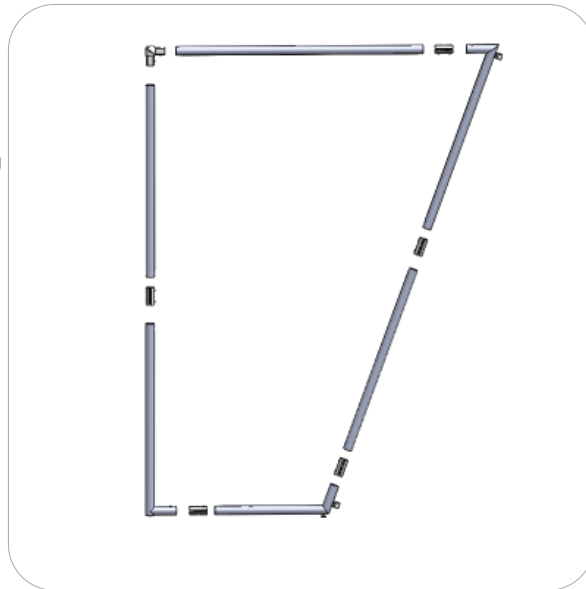

Step 4.

With Frame B laying flat on the floor, locate your pillowcase B graphic. With the pillowcase unzipped, encase Frame B by covering the frame from Bottom to Top. Repeat this step with graphic D onto your second Frame B.

Zipper located to the top of Graphic B & D

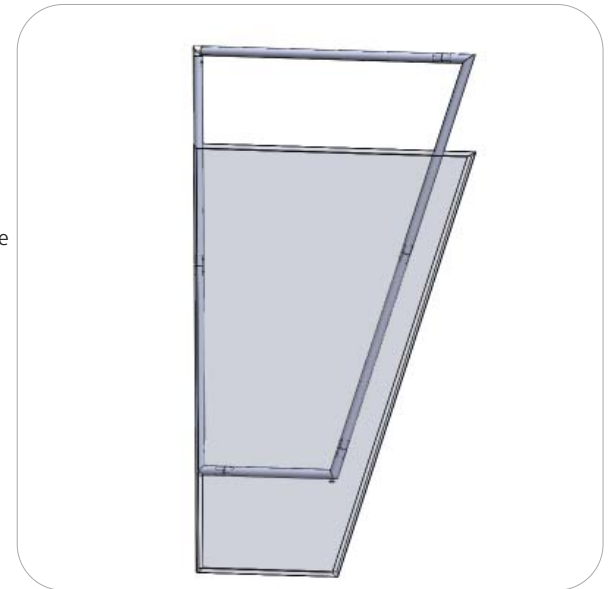

Kit Assembly

Step by Step

Step 5.

Gather both LN114-S2-650 assemblies, and 2 LN114 screws. Attach the foot to the straight side of both Frame Bs.



Step 6.

Gather the components necessary for assembling Frame C and lay them flat on the floor. Assemble in the order the Labeling Diagram instructs.

Please reference Connection Methods 1 and 2 for more details

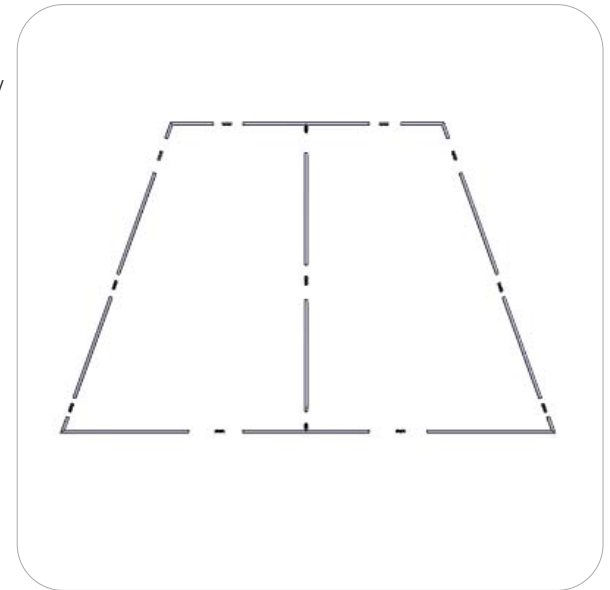
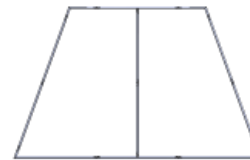

Step 7.

With Frame C laying flat on the floor, locate your pillowcase A graphic. With the pillowcase unzipped, encase Frame C by covering the frame from top to bottom.

Zipper located to the bottom of Graphic C

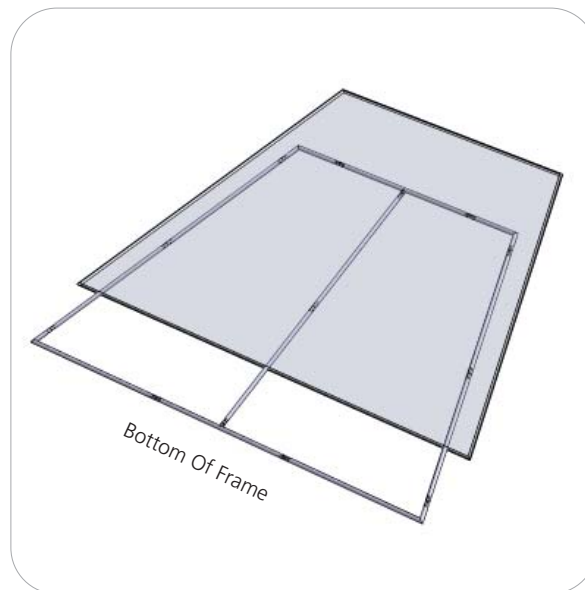
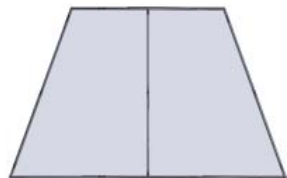

Step 8.

Attach your frames, making sure to tighten the clamps that connect frames.

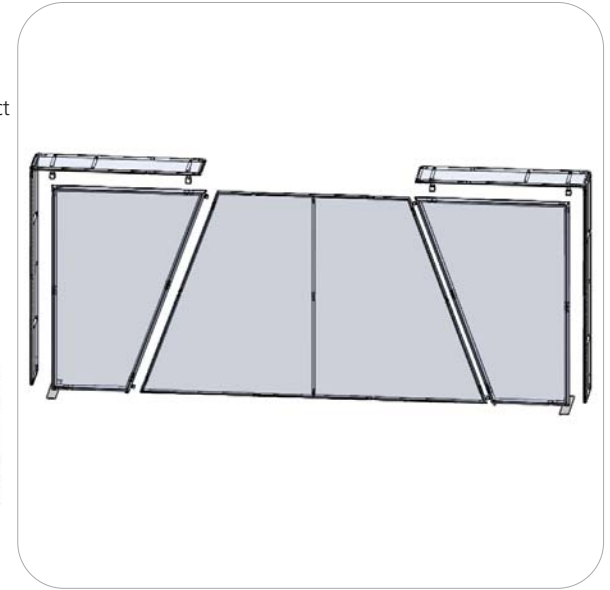
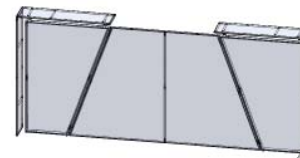

Kit Assembly

Step by Step

Step 9.

Position your PM3S2-MK monitor kiosk behind both Frame B. Push the arms of the kiosk through the holes of the graphic. Attach your monitor bracket to the protruding arms on the front side of the graphic.

