

Formulate Designer Series 10' Backwall - Kit 06

FMLT-DS-10-06

Formulate™ Designer Series 10ft displays have unique stylistic features and shapes, are portable and easy to assemble. The aluminum tube frame features snap-buttons and/ or spigot connections and zipper pillowcase fabric graphics. All displays come in portable, wheeled transit cases. Simply pull the pillowcase fabric graphic(s) over the frame and zip.



features and benefits:

- Premium aluminum tube frames with snap button / spigot assembly
- Easy to store and ship
- Quick to set up
- Weighted feet for added stability
- Two zipper pillowcase fabric graphics
- Kit includes: monitor kiosk featuring a medium monitor mount, can hold 32-55" monitor/ max weight 40lbs
- Lifetime limited hardware warranty against manufacturer defects

dimensions:

Hardware	Graphic
<p>Assembled unit: 117.6" w x 98.62" h x 41.96" d 2987mm(w) x 2505mm(h) x 1066mm(d)</p> <p>Approximate weight with cases: 155 lbs / 70.3 kgs</p>	<p>Refer to related graphic template for more information.</p> <p>Visit: www.exhibitors-handbook.com/graphic-templates</p>
<p>Shipping</p> <p>Packing case(s): 2 OCE Cases</p> <p>Shipping dimensions: OCE: Expandable case length (l) may vary 40" - 66" l x 18" w x 18" h 1016mm-1677mm(l) x 458mm(w) x 458mm(h)</p> <p>Approximate total shipping weight (includes cases & graphics): 168 lbs / 76.2 kgs</p>	<p>additional information:</p> <p>Graphic material: dye-sublimation zipper pillowcase fabric</p>

We are continually improving and modifying our product range and reserve the right to vary the specifications without prior notice. All dimensions and weights quoted are approximate and we accept no responsibility for variance. E&OE. See Graphic Templates for graphic bleed specifications.

Included In Your Kit

Tools, Components, & Connectors



ALLEN KEY SET x1



ES30 x8



LN114-SCRW x2



ES30-90B x2

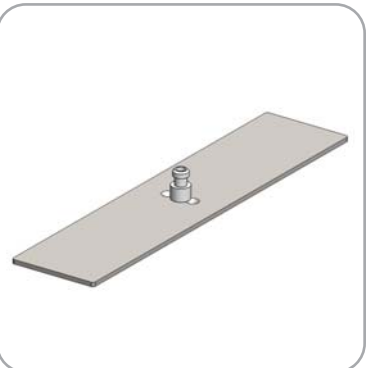

LN114-S2-450 x2



WVC-PLATE-STD x2



TC-30-90T x2



TC-30-90B x2



TC-30-T x2



TC-30-S x1

Graphics

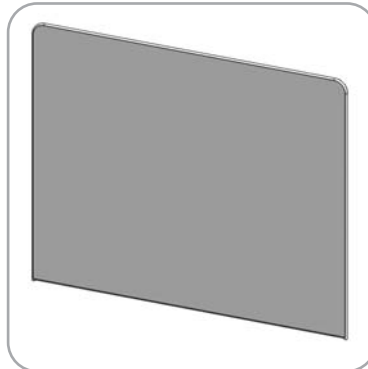



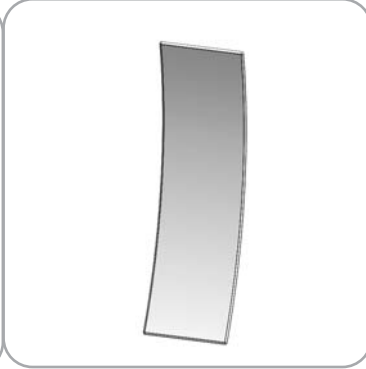



FMLT-DS-10-06-A-G x1

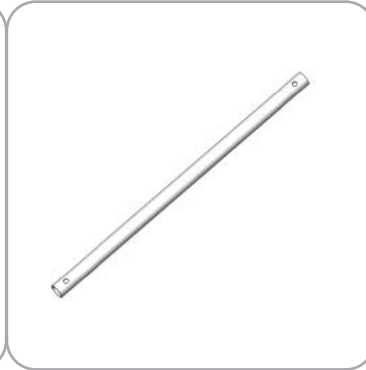

FMLT-DS-10-06-B-G x1

Included In Your Kit

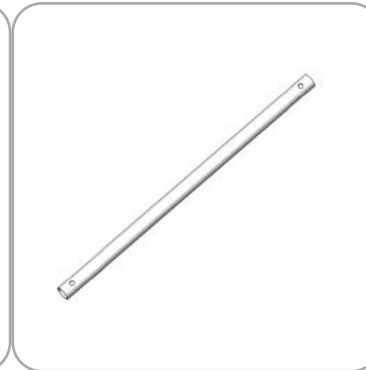
Tubes

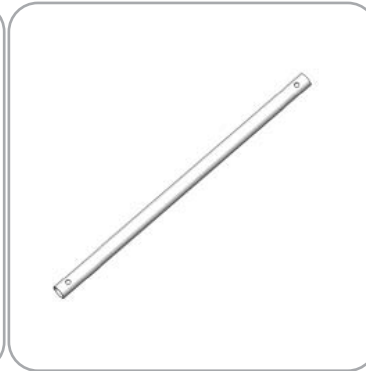
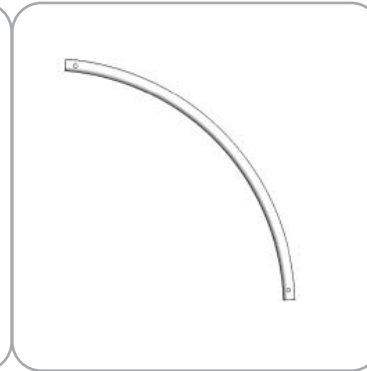
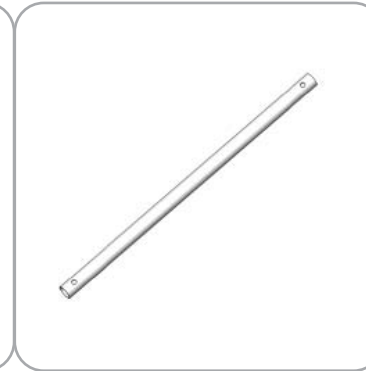
				
DS-10-06-T1 x1	DS-10-06-T2 x1	DS-10-06-T3 x4	DS-10-06-T4 x2	DS-10-06-T5 1
				
DS-10-06-T6 x1	DS-10-06-T7 x2	DS-10-06-T8 x2	DS-10-06-T9 x4	DS-10-06-T10 x1

Exploded View

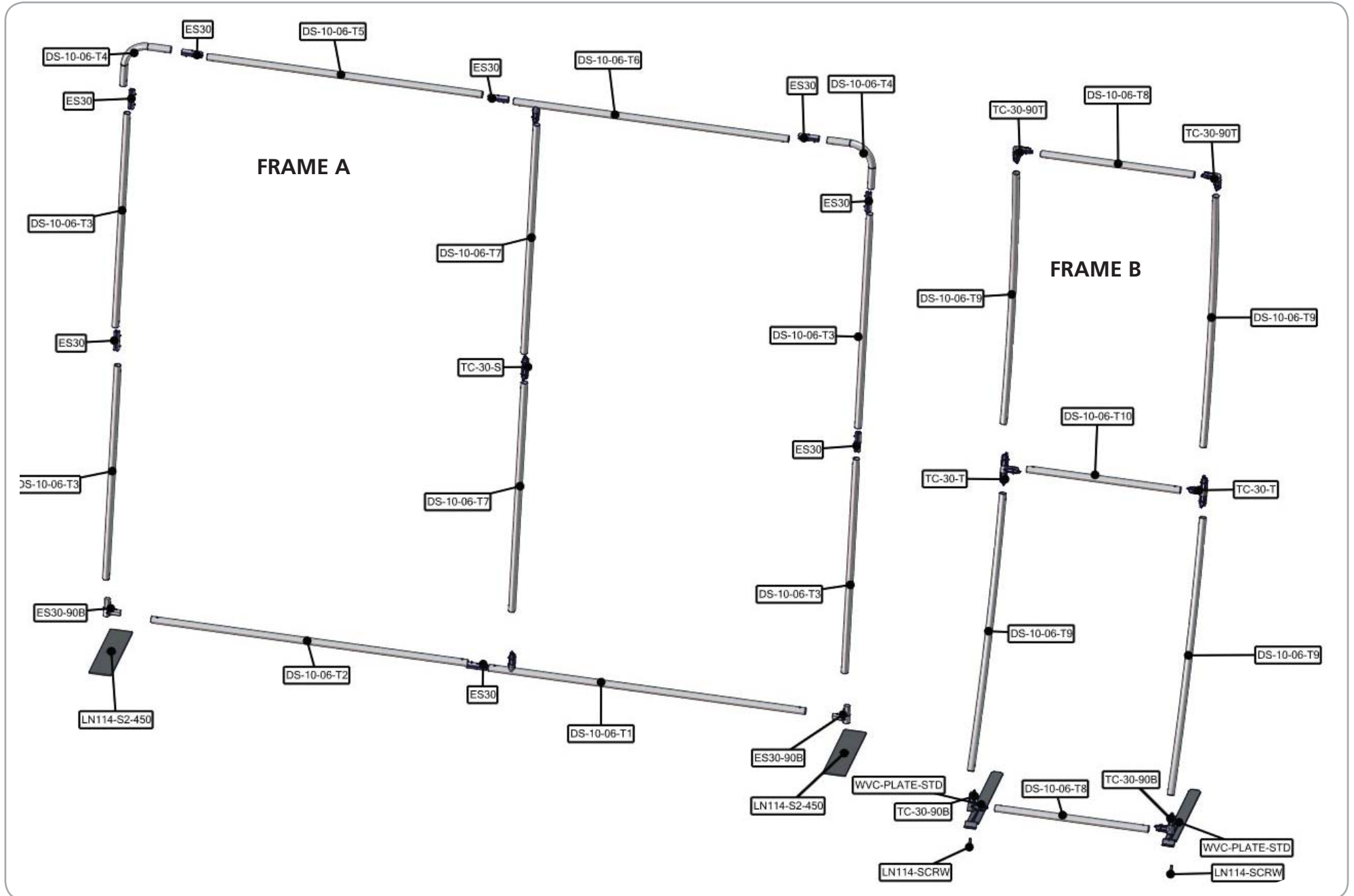

Labeling Diagram

FMLT-DS-10-06

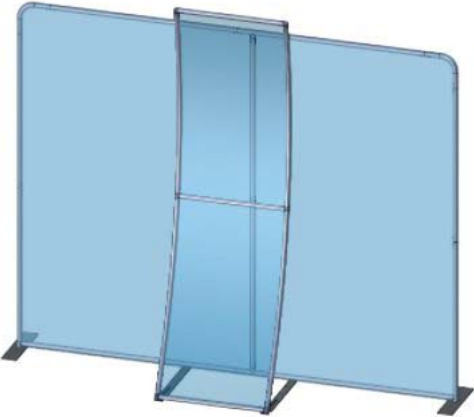
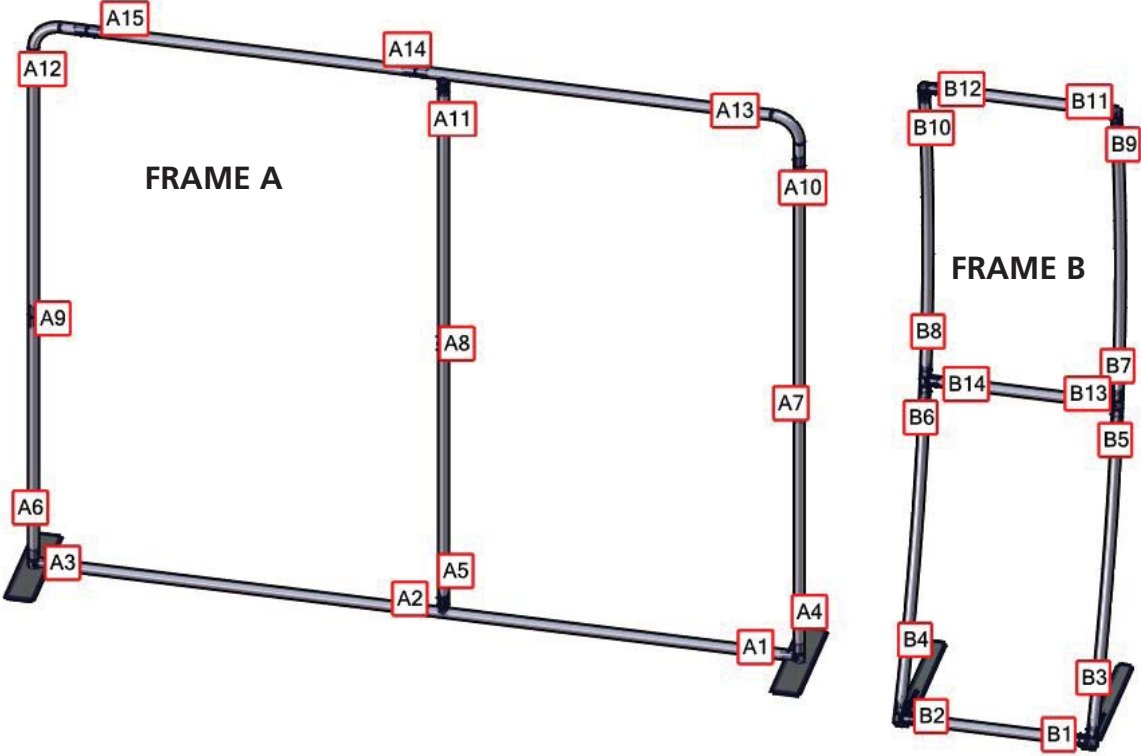

OVERHEAD VIEW

Connection Methods

Formulate™ structures use a number of different yet simple connection methods. Your kit will include one or more of the connection methods shown below. Steps within the Kit Assembly will reference a specific method for each connection point.

Connection Method 1: ES30 / ES50 / ES75

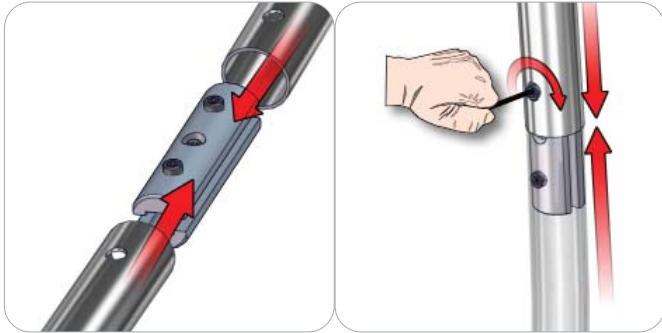

Compress the unlocked connector and slide one tube onto each end. Lock both screws carefully using your allen key tool. Be sure to lock securely, but do not overtighten.

Connection Method 2: Snap Buttons & Swage

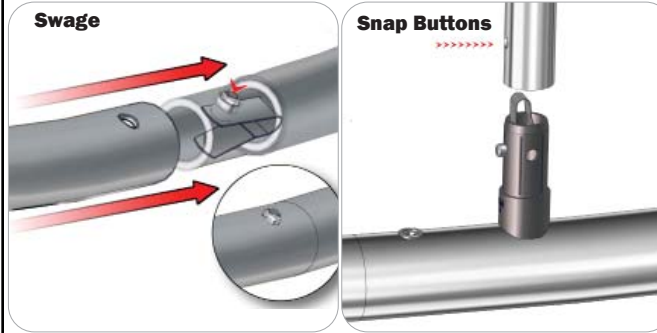

Locate the snap button on the connector or swage tube. Locate the hole on the corresponding tube. Press the snap button with your thumb and slide the tube and connector together so that the snap button snaps fully into the lock hole. To disassemble, press the snap button and pull apart.

Connection Method 3: ES30-90B / ES30-I / ES30-C

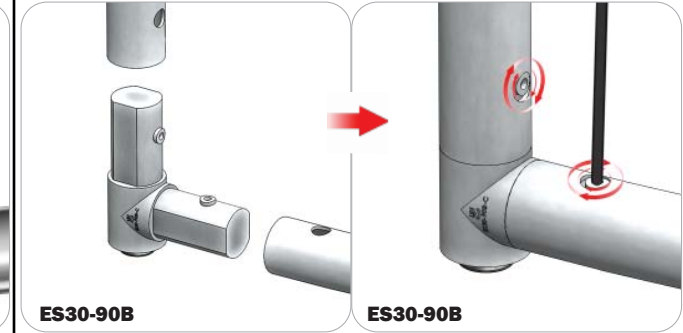

Compress one unlocked end of the connector and slide it through one tube end. Compress the other end of the connector and slide the second tube on. Lock both screws carefully using your allen key tool. Be sure to lock securely, but do not overtighten.

Connection Method 4: Tube Clamps

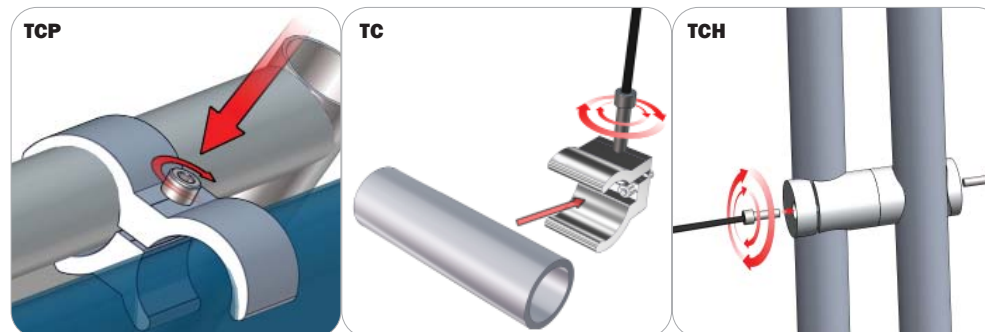

Be sure to fully assemble all frames before using clamps. With the clamp unlocked, place one tube of the first frame into the mouth of the clamp. Place the second tube (if applicable) into the second mouth of the clamp. With both frame's tubes in the clamp, be sure to lock securely, but do not overtighten.

Kit Assembly

Step by Step

Step 1.

Locate the components necessary for assembling Frame A. Assemble your frame in order according to the Labeling Diagram.

Please reference Connection Methods 1, 2, and 3 for more details.

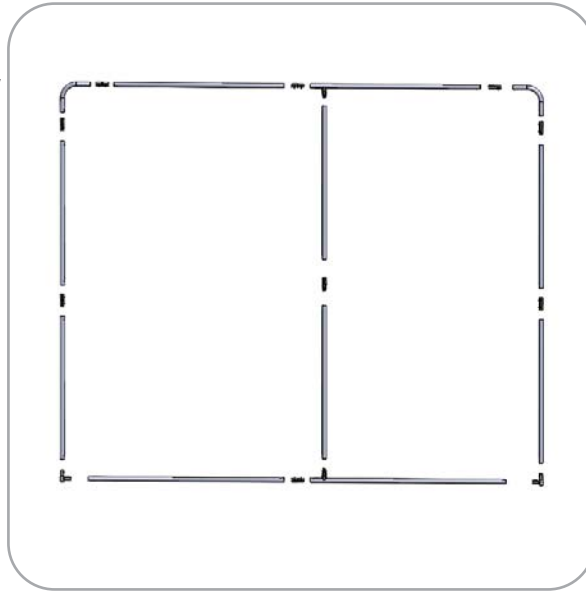
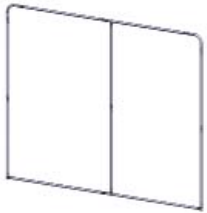

Step 3.

Fit graphic A onto Frame A. For ease of installation, pull the fabric cover over the top of the frame while the frame rests flat on the floor. Zip to enclose.

Zipper located on the bottom of Graphic A

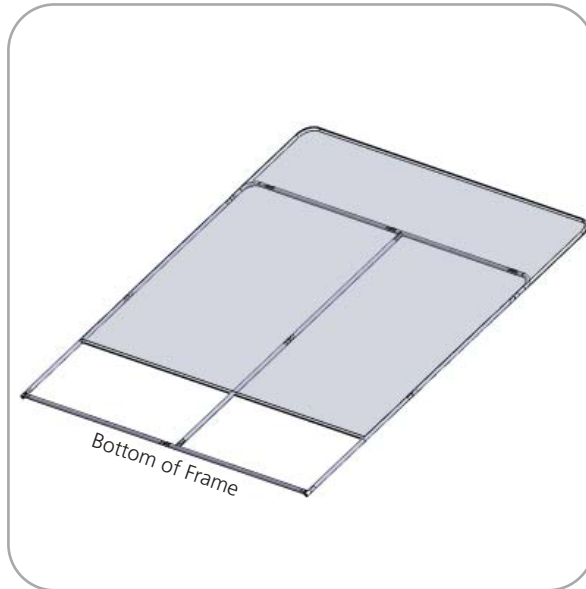
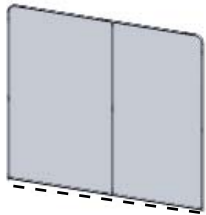

Step 2.

Locate the components necessary for assembling Frame B. Assemble your frame in order according to the Labeling Diagram.

Please reference Connection Method 2 for more details.

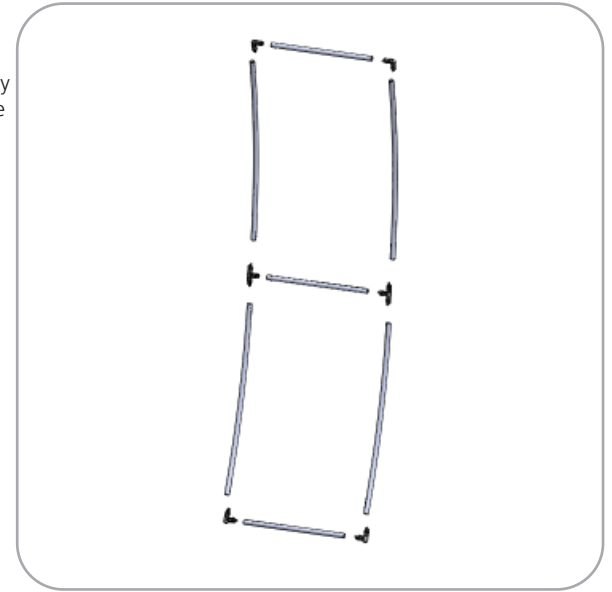

Step 4.

Fit graphic B onto Frame B. For ease of installation, pull the fabric cover over the top of the frame while the frame rests flat on the floor. Zip to enclose.

Zipper located on the bottom of Graphic B

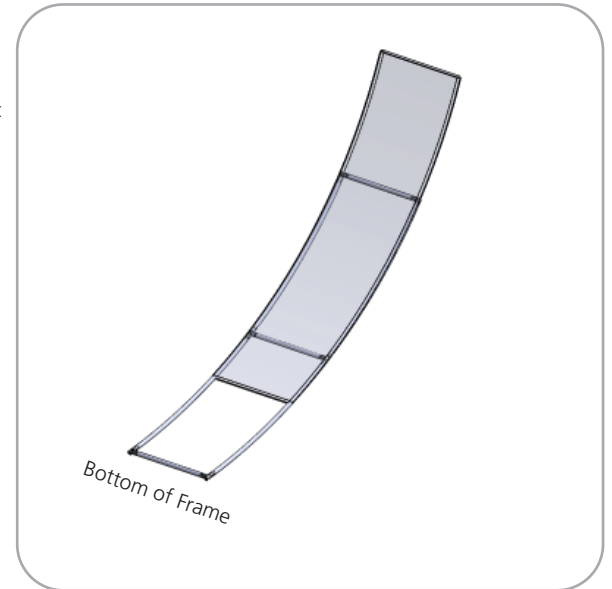

Kit Assembly

Step by Step

Step 5.

Locate both LN114-S2-450 assemblies. Attach the feet on the left and right ends of Frame A. Tighten the lock screw on the side of the ES30-90B to lock your feet into place.

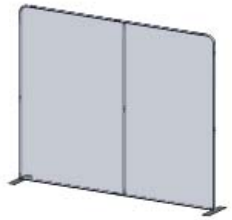

Step 6.

Locate both WVC-PLATE-STD and LN114 screws. Screw the LN114 into the WVC-PLATE-STD and into the TC-30-90B so that the greater amount of the plate sits toward the center of the frame, as shown in the figure on the right.

