

Solo

SOLO-800
SOLO-920

The Solo is a simplistic and elegantly designed banner stand. It incorporates basic design features, functionality and reliability. It is finished in anodized silver with chrome endplates. Padded carry bag is included.



Swivel foot base



Carry bag included

features and benefits:

- Standard graphic height = 79"
- Lightweight construction
- Snap top rail
- 3 piece bungee pole
- Silver base with chrome end caps
- Includes padded carry bag
- 90 day warranty against all manufacturers defects
- Single swivel-out foot

dimensions:

Hardware	Shipping
<p>Assembled unit (approximate sizes): 800: 33.07" w x 82.5" h x 12.6" d 840mm(w) x 2096mm(h) x 320mm(d)</p> <p>920: 37.8" w x 82.5" h x 12.6" d 960mm(w) x 2096mm(h) x 320mm(d)</p> <p>Base dimensions: 800: 33.07" w x 3.5" h x 12.6" d 840mm(w) x 89mm(d) x 320mm(d)</p> <p>920: 37.8" w x 3.5" h x 12.6" d 960mm(w) x 89mm(h) x 320(d)</p>	<p>Shipping dimensions - ships in one box: 800: 35" l x 5" h x 5" d 890mm(l) x 127mm(h) x 127mm(d)</p> <p>920: 40" l x 5" h x 5" d 1016mm(l) x 127mm(h) x 127mm(d)</p> <p>Shipping weight (without graphic): 800: 5 lbs / 2.27 kgs</p> <p>920: 5 lbs / 2.27 kgs</p>
<p>Graphic</p> <p>Refer to related graphic template for more information.</p> <p>WARNING: Always attach graphic to base and top rail before removing the locking pin. After fitting, the graphic should be left for 24 hours before use to ensure the adhesive bonds sufficiently. Opening the base will invalidate the product warranty.</p>	<p>additional information:</p> <p>Graphic materials: 14oz anti-curl vinyl, premium 100% opaque fabric,</p> <p>Lumina 2 banner lighting option available</p> 

We are continually improving and modifying our product range and reserve the right to vary the specifications without prior notice. All dimensions and weights quoted are approximate and we accept no responsibility for variance. E&OE. See Graphic Templates for graphic bleed specifications.

Set-up

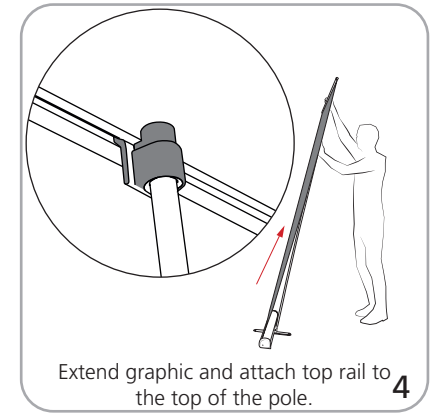
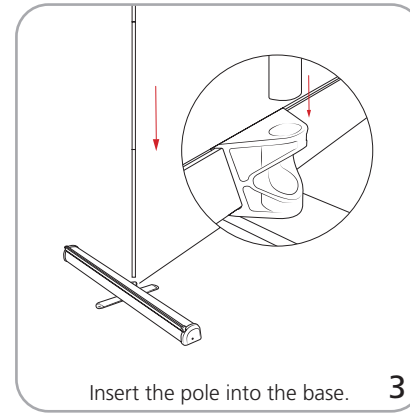
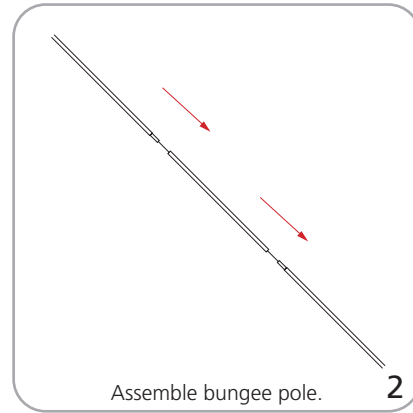
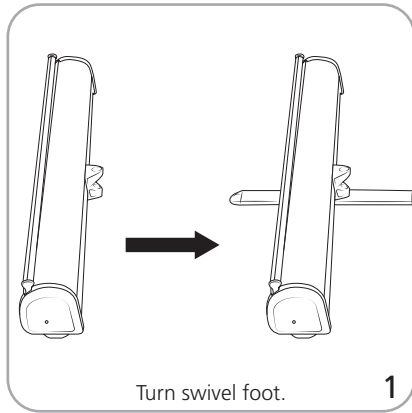

Graphic to top rail attachment

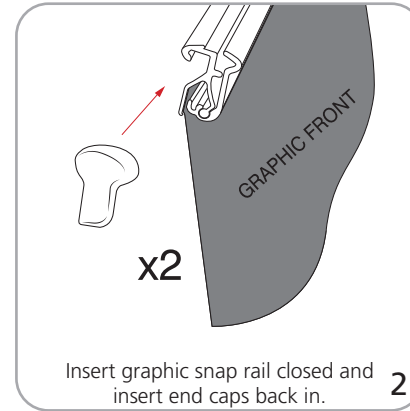
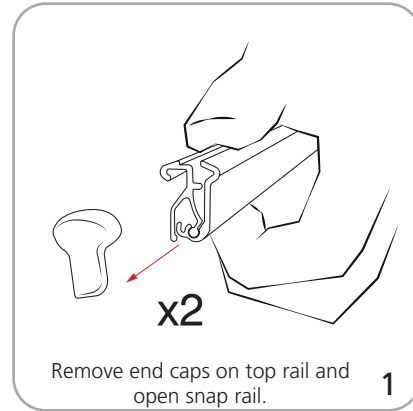

Graphic to base attachment

